

SPX 527



LIFT ANYWHERE YOU NEED!

CE
UNI EN 13000



2,7 t



3,4 - 12,1 m

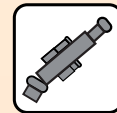

2,1 - 4,1 m



(m/t)



3,4 - 12,1 m +

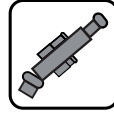



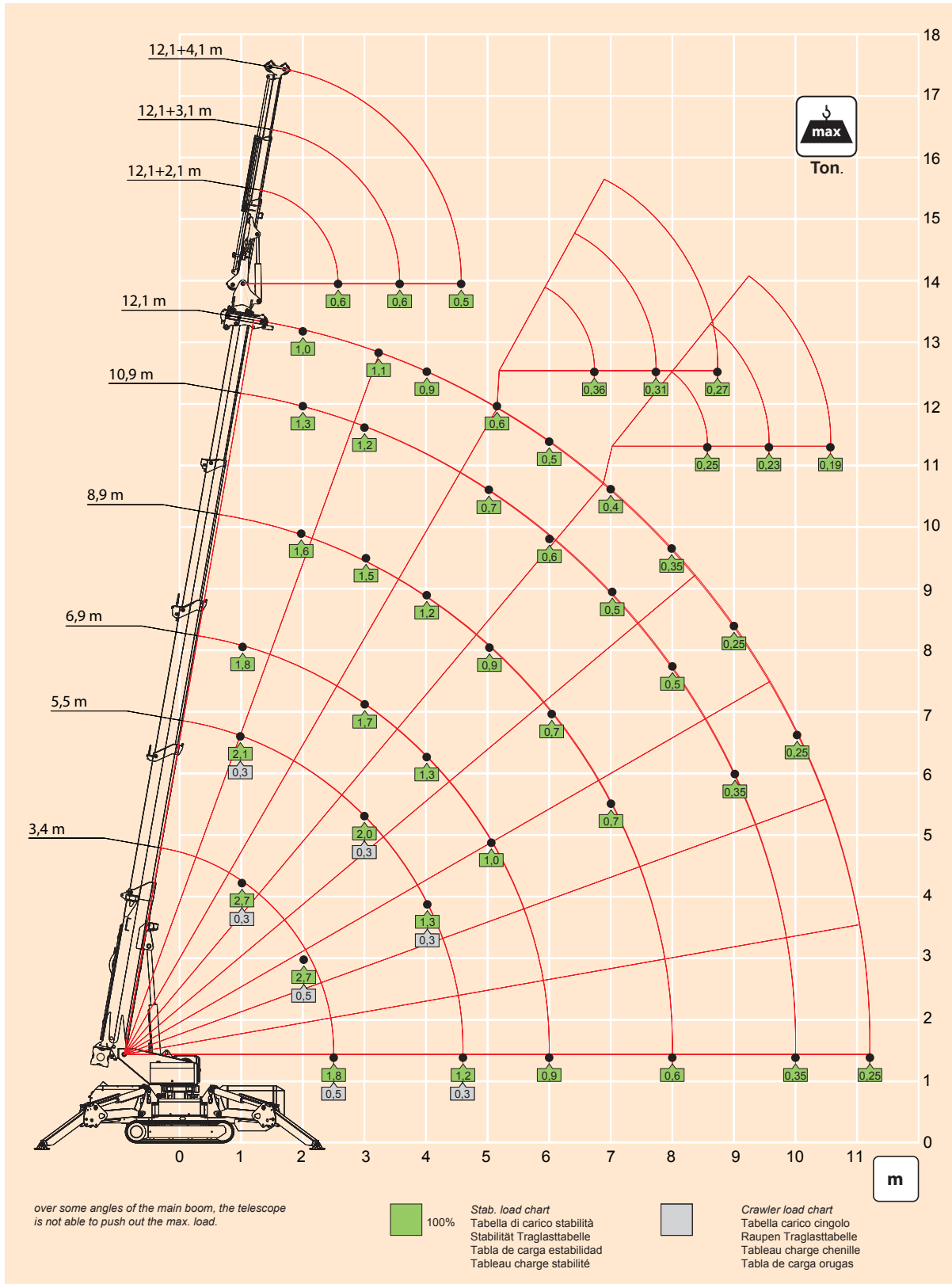



2,1 - 4,1 m



Data - Dati - Daten - Datos - Caractéristiques

	Crane Less Counterweight - Gru senza contrappeso - Kran ohne Gegengewicht - Grúa sin contrapeso - Grue sans contrepoids	3700 kg
	Counterweight - Contrappeso - Gegengewicht - Contrapeso - Contrepoids	---- kg
	4 ton Block - Blocco 4 ton - Block 4 Ton - Bloqueo 4 Ton - Bloc 4 Ton	20 kg
	Hydraulic Jib J600H - Jib idraulico J600H - Hydraulischer Ausleger J600H - Plumín hidráulico J600H - Flèche télescopique J600H	200 kg

	<p>Engine: 3 cylinders water cooled diesel, ISUZU mod. 3CB1, 2 rpm levels, EPA TIER 3 Motore: 3 cilindri diesel raffreddato a liquido, ISUZU mod. 3CB1, 2 livelli di regime, EPA TIER 3 Motor: Wassergekühlter 3 Zylinder Diesel Motor, ISUZU mod. 3CB1, 2 rpm, EPA TIER 3 Motor: Diesel 3 cilindros con refrigeración por aire, ISUZU mod. 3CB1, 2 niveles rpm, EPA TIER 3 Moteur: Diesel 3 cylindres, refroidissement à eau, ISUZU mod. 3CB1, accélérateur à 2 niveaux, EPA TIER 3</p>
---	---

	<p>Telescopic Boom: 1 base and 4 telescopic sections high-tensile structural steel. All sections synchronized and full power. Braccio Telescopico: 1 braccio principale e 4 telescopici in acciaio strutturale ad alta resistenza. Sfilo completamente idraulico e sincronizzato. Teleskopausleger: 1 Hauptausleger + 4 Hochwiderstand Stahl Teleskopausleger. Voll hydraulischer und teleskopierbarer Ausleger. Pluma Telescópica: 1 pluma principal y 4 telescópicas en acero de alta resistencia. Elementos sincronizados e hidráulicos. Flèche Téléscopique: 1 flèche principale et 4 téléscopiques en acier à haute résistance. Éléments synchronisés et hydrauliques.</p>		
	360°	approx 45" - circa 45" - ca. 45" - aproximadamente 45" - env. 45"	
	-2° + 80°	approx 15" - circa 15" - ca. 15" - aproximadamente 15" env. 15"	
	3,4 m + 12,1 m	approx 35" - circa 35" - ca. 35" - aproximadamente 35" env. 35" w	
	Rope - Fune- Seil - Cable - Câble		<p>Permissible line pulls max. Trazioni ammissibili della linea Seilzug Tracciones del cable admisibles Effort maxi au brin</p>
	S1: 0 - 30 m/min	<p>Single line Tiro a fune singola Für einfachen Strang Ramal simple Brin simple</p>	Ø 8 mm / L 60 m
			1434 da N

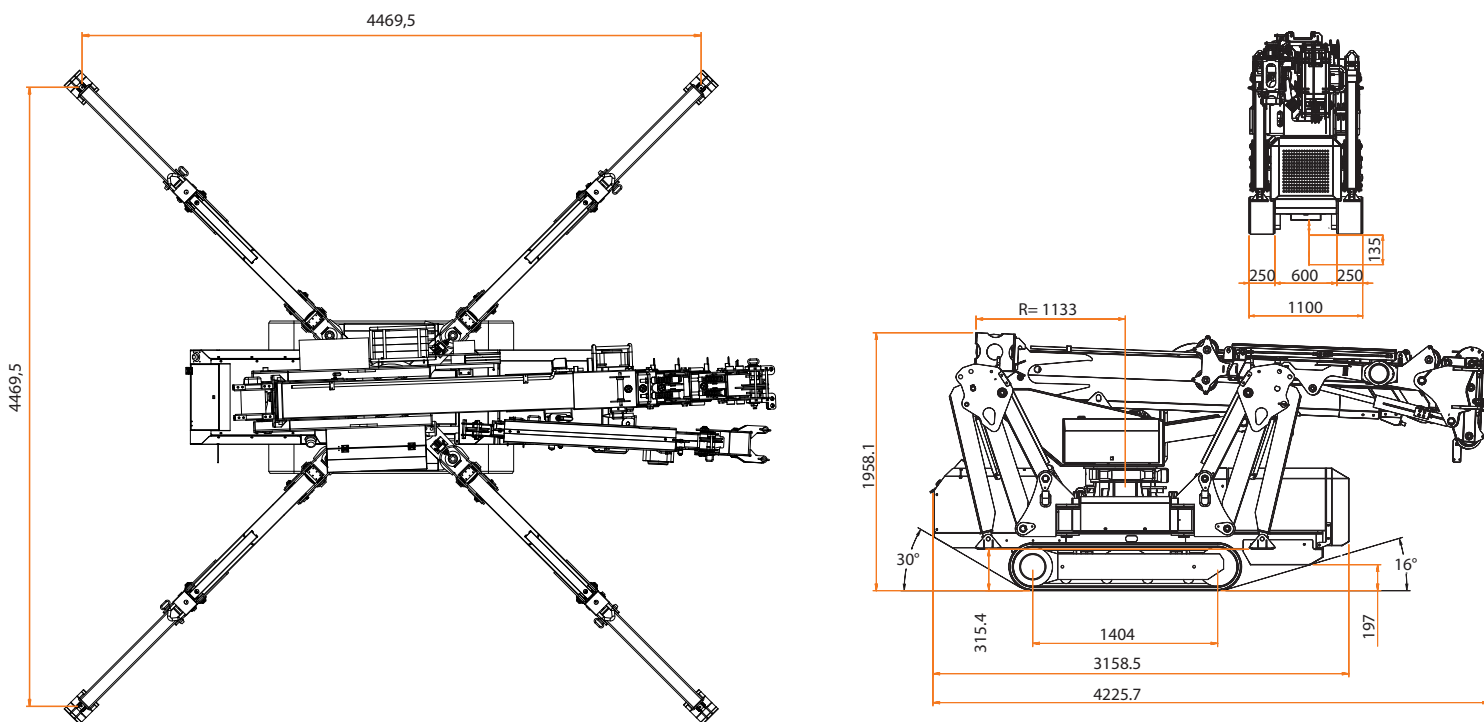

Notes: All specifications and features herein described can be changed without prior advice. All indicated data are indicative only and are not binding as crane performs differently depending on its use.

Note: Tutte le caratteristiche e le specifiche descritte possono essere soggette a variazioni senza preavviso. Tutti i dati riportati sono forniti a puro titolo informativo e non sono impegnativi dal momento che le prestazioni della macchina variano in funzione dell'utilizzo.

Hinweise: Unangekündigte Änderungen sämtlicher Eigenschaften und Daten sind möglich. Alle Angaben sind Richtwerte und nicht verbindlich da die Leistungen der Vorrichtung von deren Einsatz abhängen.

Notes: Todas las características y las especificaciones aquí indicadas pueden ser sujetas a variaciones sin aviso. Se dan todos los datos aquí indicados como simples informaciones. No se consideran como vinculantes, dado que las prestaciones del maquinario pueden variar.

Notes: Toutes les caractéristiques et le spécifications descriptives peut être sujet à variation sans préavis. Tout les données rapportés sont fourni à titre informatif et ne sont pas engager au moment que la prestation de la machine change en fonction de l'emploi.





JEMMI

JEK KO MAN-MACHINE INTERFACE



 The JEMMI system installed on the Jekko Minicrane SPX range is a very versatile and powerful instrument, also innovative compared to the traditional LMI systems. It is equipped with a **wide colour display** to ease the interaction operator-machine. It helps to check the lifted load, it controls boom position and working areas stability. Thanks to the **virtual wall** function, the operator can work under complete safety in the most narrow and restricted areas.

 Il sistema JEMMI installato sulla serie SPX di Jekko Minicrane è uno strumento estremamente versatile e potente, che si pone un passo avanti rispetto ai tradizionali limitatori di momento. E' dotato di un **ampio display a colori** che facilita l'interazione uomo-macchina. Semplifica il monitoraggio del carico sollevato, controlla la posizione del braccio e la stabilità nei vari settori di lavoro. Attraverso la funzione **muri virtuali** permette di operare con sicurezza e tranquillità anche negli ambienti più ristretti e delicati.

 Das auf der neuen Jekko Minicrane SPX Auswahl installierte JEMMI System ist ein vielseitiges, innovatives und leistungsfähiges Gerät, besonders im Vergleich zu der traditionellen LMB. Er ist mit einem **breiten Farbe-Display** ausgestattet, um die Interaktion Anwender-Maschine zu erleichtern. Es wird einfacher, das aufgehobene Gewicht zu überwachen, die Auslegerstellung und die Stabilität der Arbeitsbereiche zu kontrollieren. Dank der **virtuellen Wand-Funktion** kann der Anwender mit Sicherheit in allen schmalen und engen Bereichen arbeiten.

 El sistema JEMMI integrado en la gama SPX Jekko Minicrane es un dispositivo muy versátil y potente, que está un paso adelante respecto a los limitadores tradicionales. Está equipado con una larga **pantalla a colores** para facilitar la interacción hombre-máquina. Simplifica la monitorización de la carga levantada, controla la posición de la pluma y la estabilidad en los diferentes sectores de trabajo. Gracias a la función de los **muros virtuales** se puede trabajar en total seguridad en los espacios más reducidos y estrechos.

 Le système JEMMI installé sur Jekko Minicrane SPX est un instrument extrêmement éclectique et puissant, qui est un pas en avant par rapport aux traditionnels contrôleurs d'état de charge. Pourvu de un **gran écran à couleur** qui facilite l'interaction homme-ordinateur. Simplifie le monitoring de la charge levée, contrôle la position de la flèche et la stabilité dans les différents secteurs de travail. Grâce a la fonction **murs virtuels** permet d'opérer dans les endroits étroits et délicats avec sécurité et tranquillité.

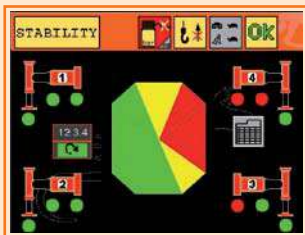

Working areas
Settori di lavoro
Arbeitsbereiche
Areas de trabajo
Zones de travail



Virtual Walls
Muri Virtuali
Virtuelle Wände
Paredes virtuales
Murs virtuels



Engine
Motore
Motor
Motor
Moteur





Alarms and Warnings
Diagnostica guasti
Warnungen und Fehler
Advertencias y Errores
Alarmes et Erreurs

 The JEMMI system includes, together with the innovative LMI, a **two-way communication radio remote control**. The two-way communication allows, not only to check simultaneously and proportionally all crane movements, but also to **receive in real time all information** about machine conditions and possible alarms. Using the optical proportional joysticks, you can move the machine thanks to the tracks control.

 Il sistema JEMMI adotta, a completamento del potente **sistema di limitazione**, un **radio-comando di sicurezza bidirezionale**. La doppia comunicazione permette non solo di controllare con proporzionalità in modo simultaneo tutti i movimenti, ma anche di **ricevere in tempo reale informazioni** sullo stato della macchina, e di evidenziare eventuali allarmi. Con i joystick ottici proporzionali è ora possibile non solo comandare il braccio gru, ma anche il movimento dei cingoli.



 Das JEMMI System enthält, mit der innovativen LMB, auch eine **Gegensprechverkehr-Fernsteuerung**. Der Gegensprechverkehr erlaubt nicht nur die Kranbewegungen gleichzeitig und proportional zu kontrollieren, sondern auch **alle Informationen** über Maschine Bedingungen und mögliche Alarme **in Echtzeit zu erhalten**. Mit den optischen proportionalen Joysticks kann man jetzt, nicht nur den Ausleger, sondern auch die Raupen Bewegungen steuern.

 El sistema JEMMI ha adoptado, junto al potente sistema de **Limitador de Cargas**, un **radio mandos bidireccional**. Esta doble comunicación permite no solo de controlar con proporcionalidad y simultáneamente todos los movimientos, sino también de **recibir a tiempo real todas las informaciones** sobre la condición de la máquina o eventuales alarmas. Con las palancas ópticas proporcionales ahora se puede, no solo mandar la pluma de la grúa, sino también los movimientos de las orugas.

 Le système JEMMI a adopté à complément du puissant **contrôleur d'état de charge**, un **radiocommande a sécurité bidirectionnel**. La double communication ne permet pas seulement de vérifier la proportionnalité en manière simultanée tous les mouvements, mais aussi de **recevoir des informations en temps réel** sur l'état de la machine, et de mettre en évidence toutes les alarmes. Avec le joystick optique proportionnelle est possible maintenant ne seulement pas piloter la flèche de la grue, mais aussi le mouvement des chenilles.